

PLASTIC PALLETS



INDIA'S LARGEST SELLING INJECTION MOULDED PALLETS

Supreme presents modern technology Injection moulded plastic pallets, designed to increase the efficiency in storage & product distribution system while ensuring human & product safety.

THE CORRECT WAY FOR USING PALLET



Normal Temperature



Proper Handling



Unified Load

THE INCORRECT WAY FOR USING PALLET



Insolation



Wild Operation



Unequal Force

ADVANTAGE OF PLASTIC PALLETS



Environment



Sanitation



Durable



No Need Repair



Moth Proofing

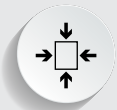

4 Way



recycle

Material Handling Pallets *Handle without care!*

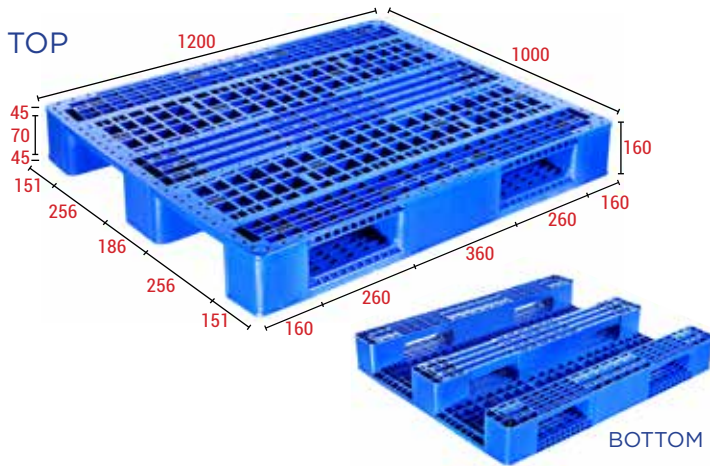

SIM121016 PDSS HW

(Supreme Injection Moulded Perforated Deck Single Side Heavy Weight)

Dimension	1200x1000x160 (mm)	Static	6000 kg. unified load
Material	HDPE/PP	Dynamic	upto 1000-1200 kg. unified load
Colour	Blue / Grey / Green	Racking	upto 1000-1200 kg. unified load



4-Way



2-Way



2-Way

SIM121016 PDSS MW

(Supreme Injection Moulded Perforated Deck Single Side Medium Weight)

Dimension	1200x1000x160 (mm)	Static	5000 kg. unified load
Material	HDPE/PP	Dynamic	upto 1000 kg. unified load
Colour	Blue / Grey / Green	Racking	upto 1000 kg. unified load



4-Way



2-Way



2-Way

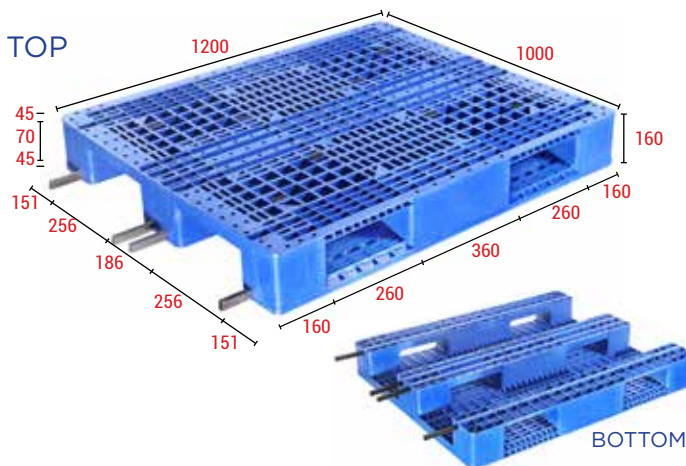
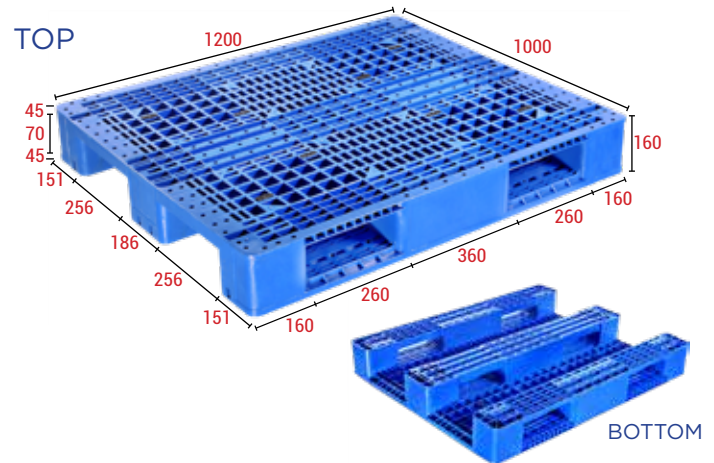

SIM121016 PDSS SR

(Supreme Injection Moulded Steel Reinforced Perforated Deck Single Side)

Dimension	1200x1000x160 (mm)	Static	6000 kg. unified load
Material	HDPE/PP	Dynamic	upto 1000 kg. unified load
Colour	Blue / Grey / Green	Racking	upto 1000 kg. unified load



4-Way



2-Way



2-Way

SIM121016 AR PDSS

(Supreme Injection Moulded Arrow Perforated Deck Single Side)

Dimension	1200x1000x160 (mm)	Static	4000 kg. unified load
Material	HDPE/PP	Dynamic	upto 1000 kg. unified load
Colour	Blue / Grey / Green	Racking	upto 1000 kg. unified load



4-Way



2-Way



2-Way

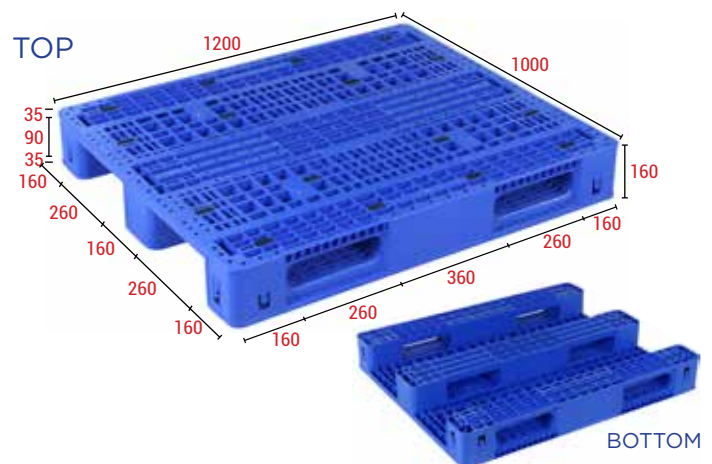

SIM121016 AR PDSS 4SR LS (MW)

(Supreme Injection Moulded Arrow Perforated Deck Single Side 4 Steel Reinforced Length Side, Medium Weight)

Dimension	1200x1000x160 (mm)	Static	3000 kg. unified load
Material	HDPE/PP	Dynamic	1000 kg. unified load
Colour	Blue / Grey / Green	Racking	500 kg. unified load



4-Way



2-Way



2-Way

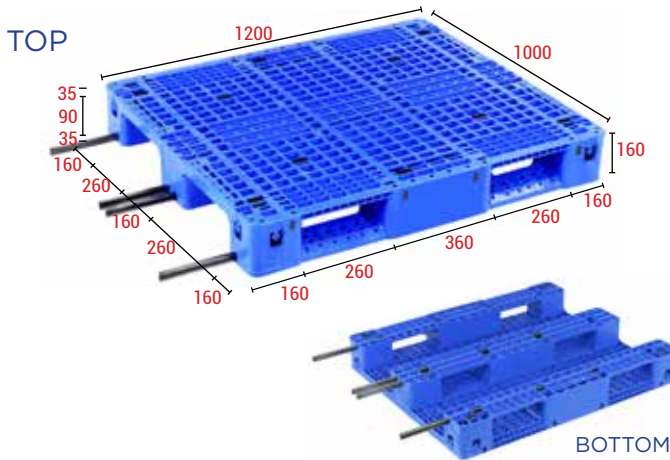
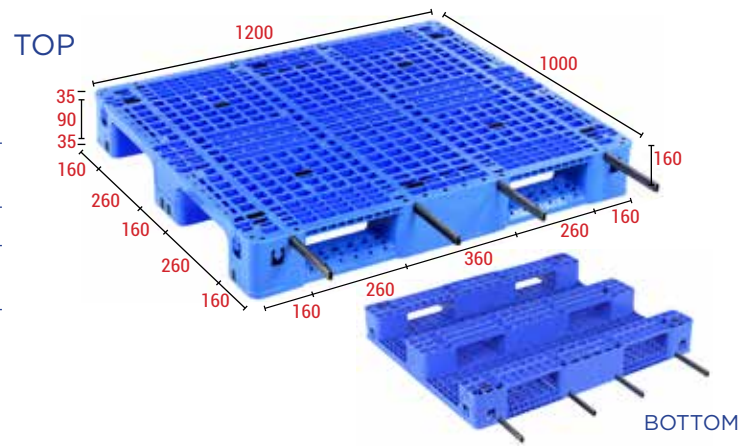

SIM121016 AR PDSS 4SR WS (MW)

(Supreme Injection Moulded Arrow Perforated Deck Single Side 4 Steel Reinforced Width Side, Medium Weight)

Dimension	1200x1000x160 (mm)	Static	2000 kg. unified load
Material	HDPE/PP	Dynamic	750 kg. unified load
Colour	Blue / Grey / Green	Racking	750 kg. unified load



4-Way



2-Way



2-Way

SIM121016 AR PDSS 8 SR

(Supreme Injection Moulded Arrow Perforated Deck 8 Steel Reinforced Single Side)

Dimension	1200x1000x160 (mm)	Static	6000 kg. unified load
Material	HDPE/PP	Dynamic	1500 kg. unified load
Colour	Blue / Grey / Green	Racking	1200 kg. unified load



4-Way



2-Way



2-Way

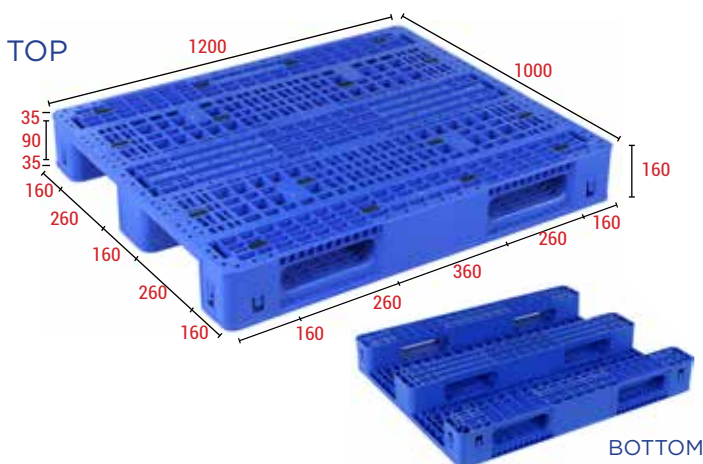
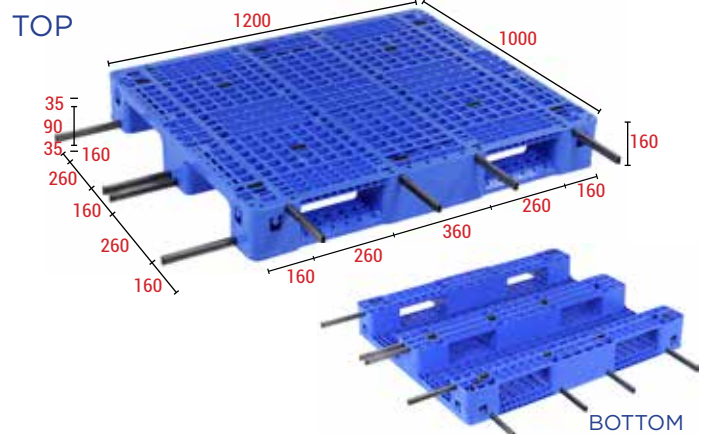

SIM121016 AR PDSS LW

(Supreme Injection Moulded Arrow Perforated Deck Single Side Low Weight)

Dimension	1200x1000x160 (mm)	Static	2000 kg. unified load
Material	HDPE/PP	Dynamic	500 kg. unified load
Colour	Blue / Grey / Green	Racking	500 kg. unified load



4-Way



2-Way



2-Way

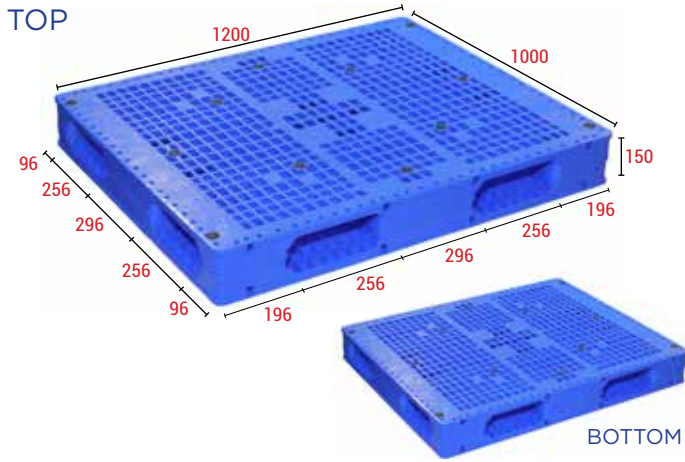

SIM121015 PDR PERFORATED DECK REVERSIBLE

(Supreme Injection Moulded Perforated Deck Reversible)

Dimension	1200x1000x150 (mm)	Static	4000 kg. unified load
Material	HDPE/PP	Dynamic	800 kg. unified load
Colour	Blue / Grey / Green	Racking	700 kg. unified load



SIM121015 PDD MW DOUBLE DECK

(Supreme Injection Moulded Perforated Double Deck Medium Weight)

Dimension	1200x1000x150 (mm)	Static	4000 kg. unified load
Material	HDPE/PP	Dynamic	800 kg. unified load
Colour	Blue / Grey / Green	Racking	700 kg. unified load

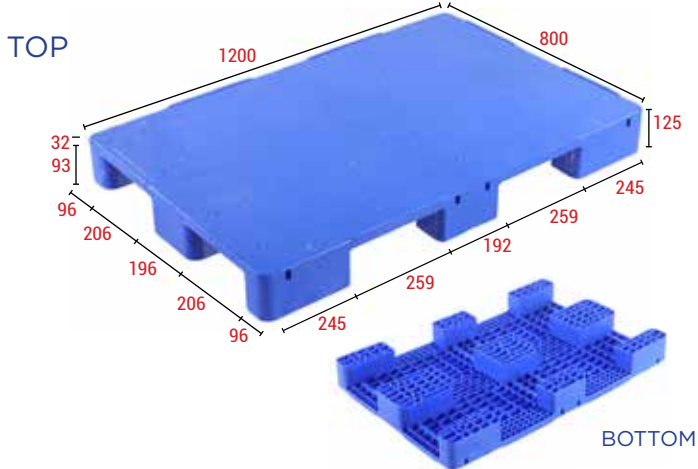
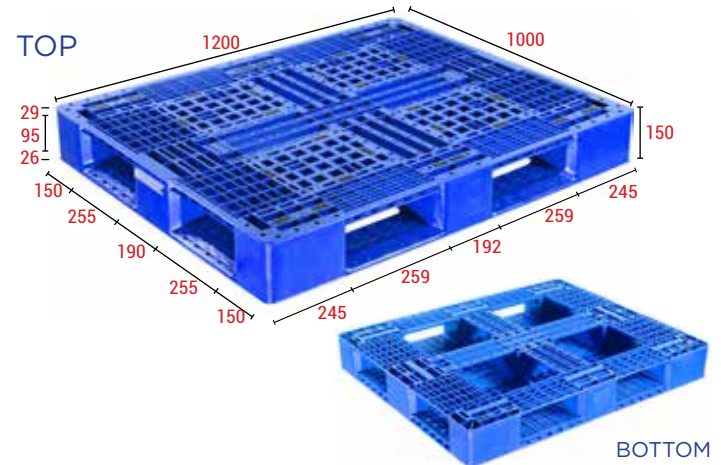

SIM1280125 CDSS 9L

(Supreme Injection Moulded Close Deck Single Side 9 Legs)

Dimension	1200x800x125 (mm)	Static	2500 kg. unified load
Material	HDPE/PP	Dynamic	500 kg. unified load
Colour	Blue / Grey / Green	Racking	N/A



SIM1280125 CDSS SR 9L

(Supreme Injection Moulded Steel Reinforced Close Deck Single Side 9 Legs)

Dimension	1200x800x125 (mm)	Static	2500 kg. unified load
Material	HDPE/PP	Dynamic	upto700 kg. unified load
Colour	Blue / Grey / Green	Racking	N/A

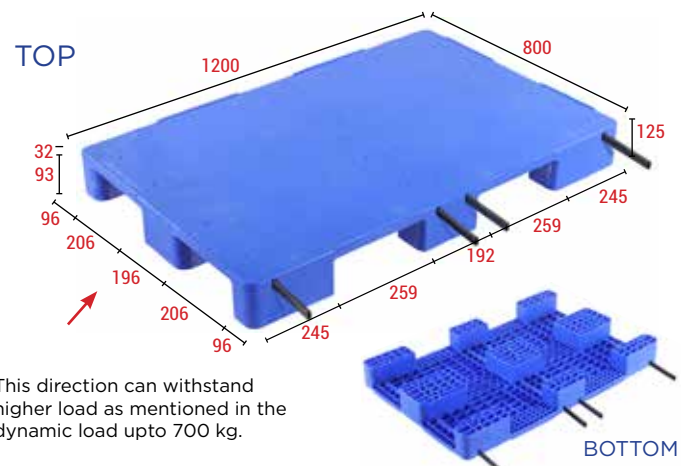

This direction can withstand higher load as mentioned in the dynamic load upto 700 kg.

SIM1280125 PDSS 9L

(Supreme Injection Moulded Perforated Deck Single Side 9 Legs)

Dimension	1200x800x125 (mm)	Static	2000 kg. unified load
Material	HDPE/PP	Dynamic	500 kg. unified load
Colour	Blue / Grey / Green	Racking	N/A



4-Way



4-Way



4-Way

TOP

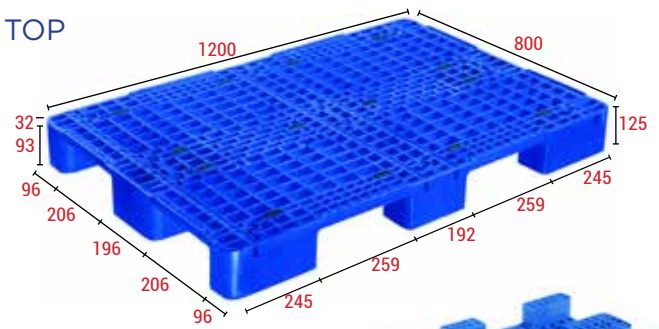

BOTTOM

TOP

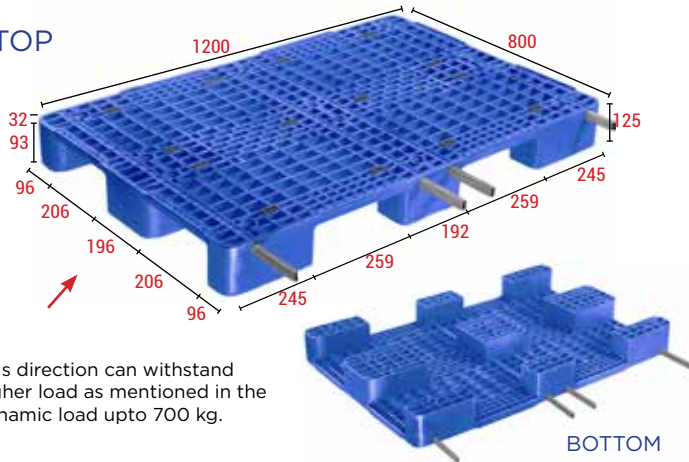

This direction can withstand higher load as mentioned in the dynamic load upto 700 kg.

BOTTOM

SIM1280125 PDSS SR 9L

(Supreme Injection Moulded Steel Reinforced Perforated Deck Single Side 9 Legs)

Dimension	1200x800x125 (mm)	Static	2500 kg. unified load
Material	HDPE/PP	Dynamic	upto 700 kg. unified load
Colour	Blue / Grey / Green	Racking	N/A



4-Way



4-Way



4-Way

SIM1210125 CDSS 9L

(Supreme Injection Moulded Close Deck Single Side 9 Legs)

Dimension	1200x1000x125 (mm)	Static	3000 kg. unified load
Material	HDPE/PP	Dynamic	750 kg. unified load
Colour	Blue / Grey / Green	Racking	N/A



4-Way



4-Way



4-Way

TOP

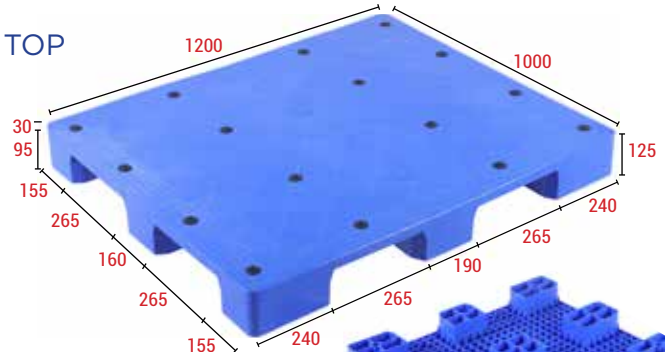

BOTTOM

TOP

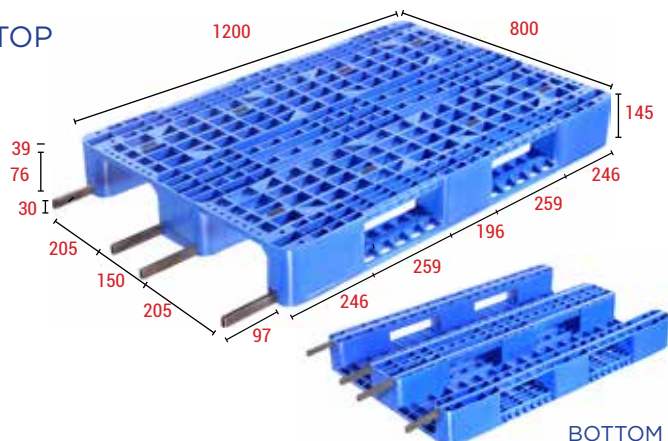

BOTTOM

SIM1280145 PDSS SR

(Supreme Injection Moulded Three Runner Steel Reinforced Perforated Deck Single Side)

Dimension	1200x800x145 (mm)	Static	2000 kg. unified load
Material	HDPE/PP	Dynamic	500 kg. unified load
Colour	Blue / Grey / Green	Racking	500 kg. unified load



4-Way



2-Way



2-Way

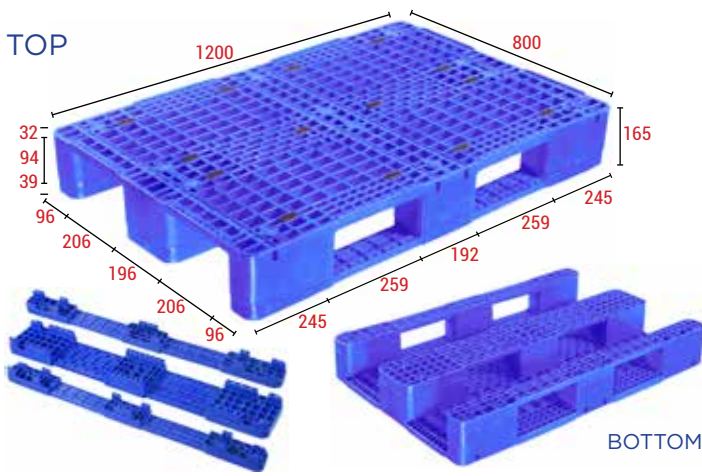

SIM1280165 PDSS 3S

(Supreme Injection Moulded Perforated Deck Single Side with 3 Detachable Skids)

Dimension	1200x800x165 (mm)	Static	2500 kg. unified load
Material	HDPE/PP	Dynamic	upto 750 kg. unified load
Colour	Blue / Grey / Green	Racking	upto 500 kg. unified load



SIM1280165 PDSS SR 3S

(Supreme Injection Moulded Steel Reinforced Perforated Deck Single Side with 3 Detachable Skids)

Dimension	1200x800x165 (mm)	Static	2500 kg. unified load
Material	HDPE/PP	Dynamic	
Colour	Blue / Grey / Green	Racking	upto 500 kg. unified load



↗ This direction can withstand higher load as mentioned in the dynamic load upto 1000 kg.

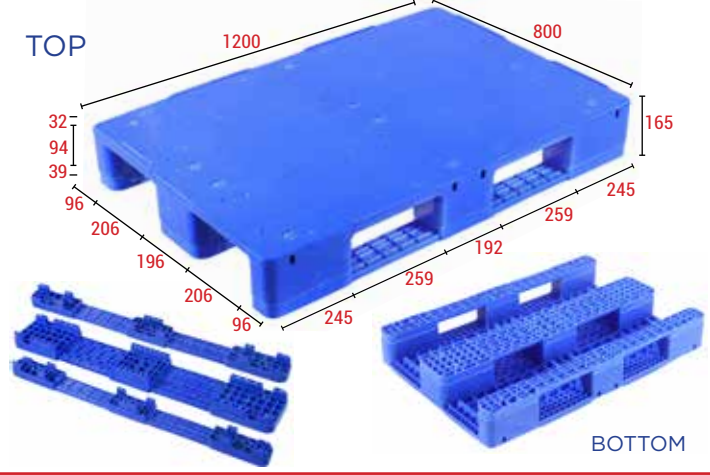
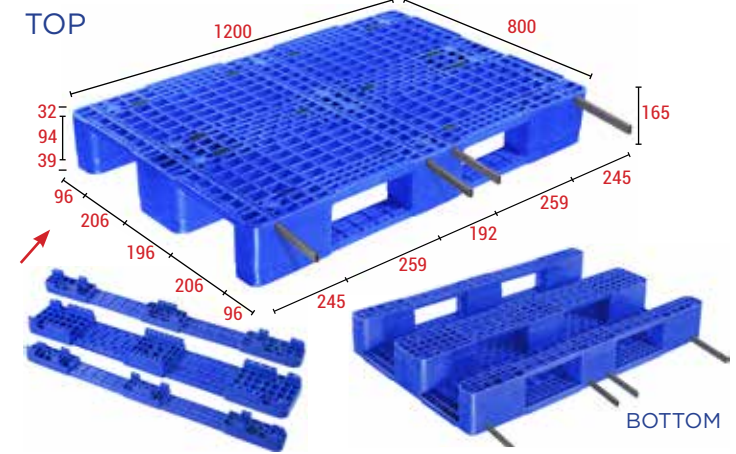

SIM1280165 CDSS 3S

(Supreme Injection Moulded Perforated Deck Single Side with 3 Detachable Skids)

Dimension	1200x800x165 (mm)	Static	2500 kg. unified load
Material	HDPE/PP	Dynamic	upto 700 kg. unified load
Colour	Blue / Grey / Green	Racking	upto 500 kg. unified load



SIM1280165 CDSS SR 3S

(Supreme Injection Moulded Arrow Perforated Deck Single Side Low Weight)

Dimension	1200x800x165 (mm)	Static	2500 kg. unified load
Material	HDPE/PP	Dynamic	upto 1000 kg. unified load
Colour	Blue / Grey / Green	Racking	upto 500 kg. unified load



↗ This direction can withstand higher load as mentioned in the dynamic load upto 1000 kg.

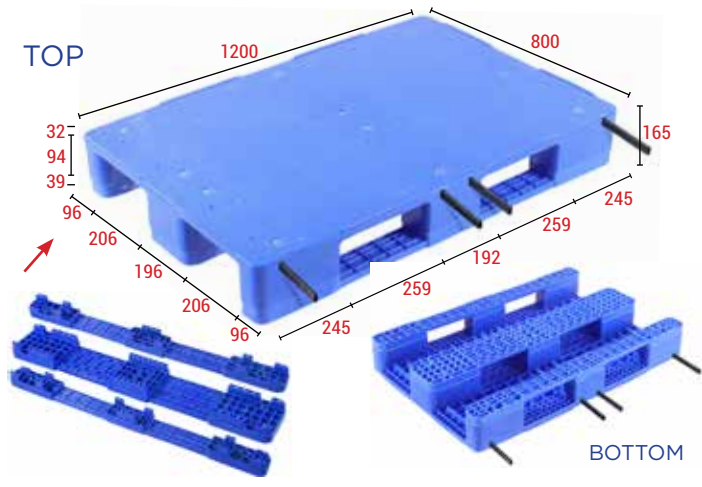

SIM131115 PDD (Reversible)

DOUBLE DECK

(Supreme Injection Moulded Perforated Double Deck)

Dimension	1300x1100x150 (mm)	Static	6000 kg. unified load
Material	HDPE/PP	Dynamic	1500 kg. unified load
Colour	Blue / Grey / Green	Racking	upto 1000 kg. unified load



4-Way



2-Way



2-Way

TOP

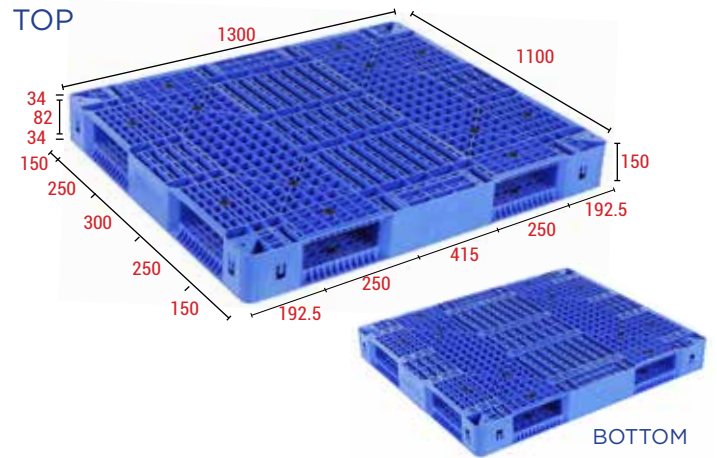

BOTTOM

TOP

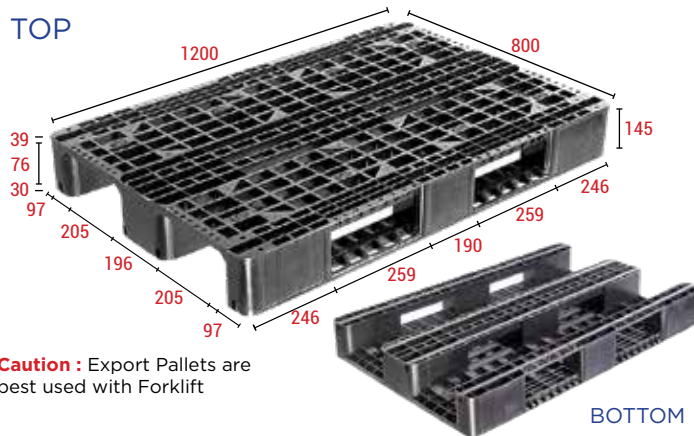

BOTTOM

Caution : Export Pallets are best used with Forklift

SIM1280145 PDSS EXP

One Time Use Only

(Supreme Injection Moulded Perforated Deck Single Side, Export Purpose)

Dimension	1200x800x145 (mm)	Static	2000 kg. unified load
Material	HDPE/PP	Dynamic	upto 1000 kg. unified load
Colour	Blue / Grey / Green	Racking	N/A



4-Way



2-Way



2-Way

SIM121013 PDN 9L EXP

One Time Use Only

(Supreme Injection Moulded Export Purpose Perforated Deck Nestable 9 Legs)

Dimension	1200x1000x130 (mm)	Static	2000 kg. unified load
Material	HDPE/PP	Dynamic	1000 kg. unified load
Colour	Blue / Grey / Green	Racking	N/A



4-Way



4-Way



4-Way

Caution : Export Pallets are best used with Forklift

TOP

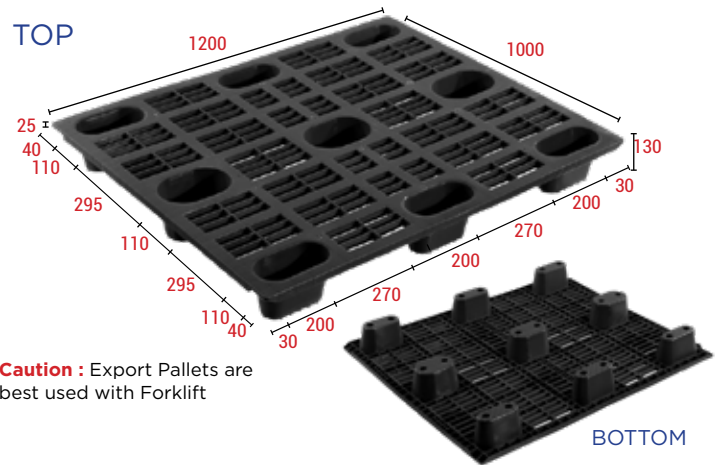

BOTTOM

Caution : Export Pallets are best used with Forklift

TOP

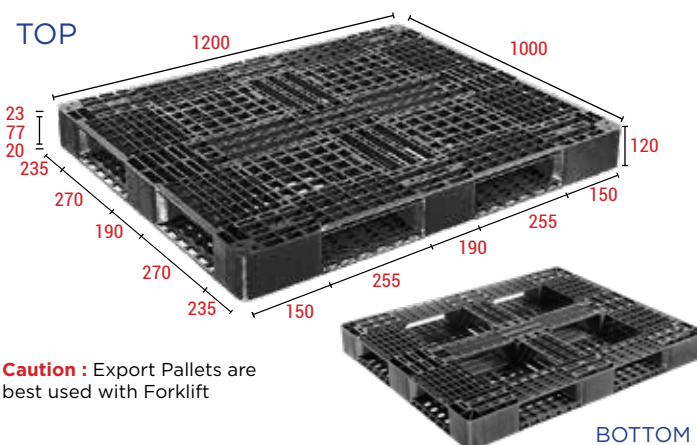

BOTTOM

Caution : Export Pallets are best used with Forklift

SIM121012 PDD LW

One Time Use Only

(Supreme Injection Moulded Perforated Double Deck Light Weight)

Dimension	1200x1000x120 (mm)	Static	2000 kg. unified load
Material	HDPE/PP	Dynamic	1000 kg. unified load
Colour	Blue / Grey / Green	Racking	N/A



4-Way



2-Way



2-Way

SIM11112 PDD EXP**One Time Use Only**

(Supreme Injection Moulded Export Purpose Perforated Double Deck)

Dimension	1100x1100x120 (mm)	Static	2000 kg. unified load
Material	HDPE/PP	Dynamic	1000 kg. unified load
Colour	Blue / Grey / Green	Racking	N/A



4-Way



N/A



N/A

TOP

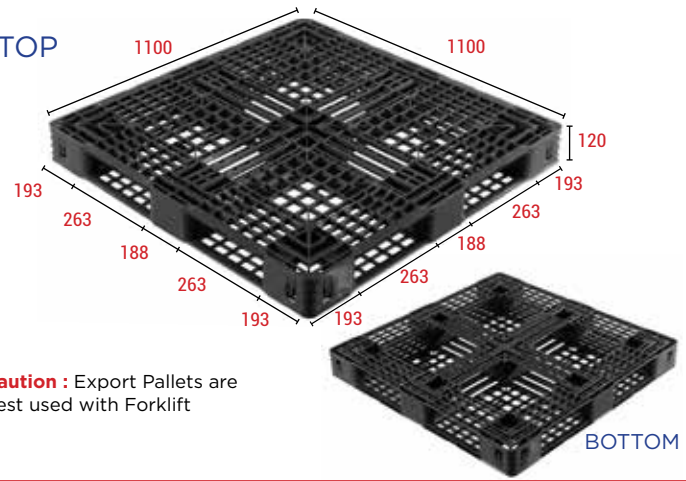
**Caution :** Export Pallets are best used with Forklift

BOTTOM

TOP

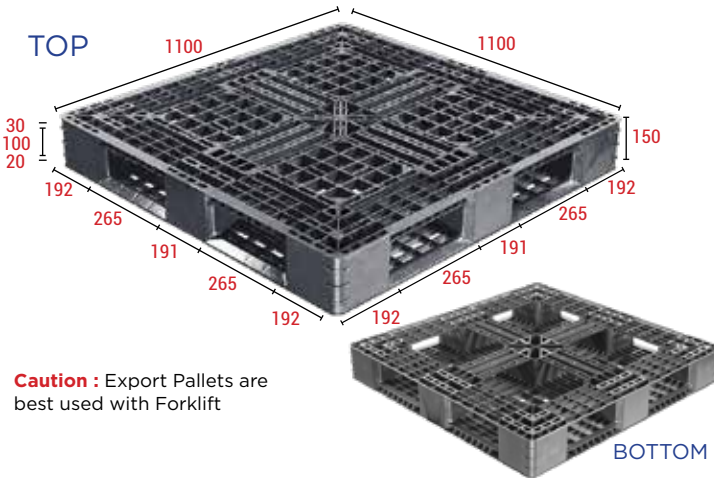
**Caution :** Export Pallets are best used with Forklift

BOTTOM

SIM11115 PDD EXP**One Time Use Only**

(Supreme Injection Moulded Export Purpose Perforated Double Deck)

Dimension	1100x1100x150 (mm)	Static	2000 kg. unified load
Material	HDPE/PP	Dynamic	1000 kg. unified load
Colour	Blue / Grey / Green	Racking	N/A



4-Way



N/A



N/A

TOP

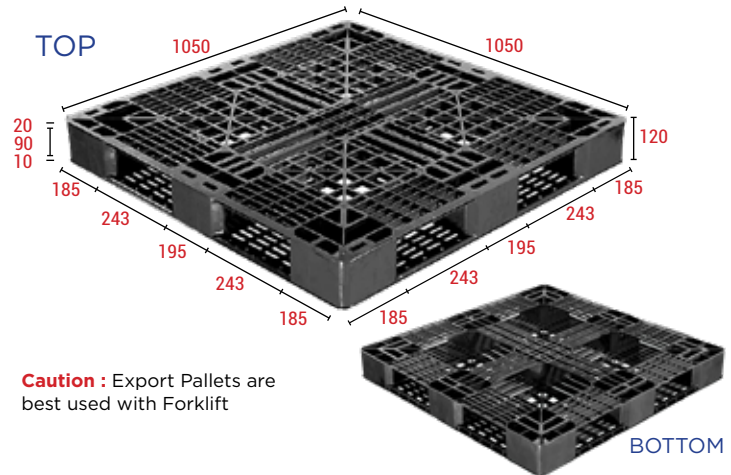
**Caution :** Export Pallets are best used with Forklift

BOTTOM

SIM105105 PDD EXP**One Time Use Only**

(Supreme Injection Moulded export Purpose Perforated Double Deck)

Dimension	1050x1050x120 (mm)	Static	2000 kg. unified load
Material	HDPE/PP	Dynamic	1000 kg. unified load
Colour	Blue / Grey / Green	Racking	N/A



4-Way



2-Way



2-Way

Supreme[®]
People who know plastics best**THE SUPREME INDUSTRIES LIMITED**

• **Mumbai:** Solitaire Corporate Park, Building No. 11 , 6th Floor, Andheri Ghatkopar Link Road, Chakala,Andheri (E), Mumbai-40093. Tel.: 022-4043 0000, 3084 0000, Fax: 022-4043 0099 • **Noida:** 701 , Tower B, World Trade Tower, Plot-C-OI , Sector-16, Noida-201301. Tel.: 0120-666 00 00 / 041 / 042 / 043, Fax: 0120-666 00 99 • **Chennai:** No. 36, lind Floor, 1st Main Road, C IT Nagar, Nandanam, Chennai-600035. Tel.: 09444077688/044-39811167, Fax: 044-43850498 • **Kolkata:** 601 , Central Plaza, 2/6 Sarat Bose Road, Kolkata-700020. Tel.: 033-24858837 / 24858839 / 24858578, Fax: 033-24858838 • **Hyderabad:** 2nd Floor, 3-5-900/1 , Opp.Pantaloon stores, Old MLA Quarters Road, Himayath Nagar, Hyderabad-500029. Tel.: 040-23221160140 / 30 • **Ahmedabad:** S-1, Mahirishi Complex, 2nd Floor, Nr. Sardar Patel colony, Usmanpura,Ahmedabad. Tel.: 079-27680903 / 27681361 , 30028374175 (DIRECT), Mobile No: 9825300765, Fax: 079-27680043 • **Bangalore:** 'Solus' (Jain Heights), Unit A4& B4 , 4th Floor, No. 2, 1st Cross, J.C.Road, Bangalore-560002. Tel.: 080-30913704 / 30913709122210711 • **Kanpur:** 311 , Annexe, City Centre Mall Road, Kanpur-208001. Telefax: 0512-2332276 • **Pune:** "Antariksha Signature", Plot No. 6 & 7, SIN. 105/1/1 , Near Radha Chowk, Opp Banglore Highway, Baner, Pune -411045. Tel.: 020-67349900/01 , 020-67349926

Email : info@supreme.co.inWebsite : www.supreme.co.in